



LIVE THE BRAAI LIFE

## CAMP CHEF LP

MODEL No 6530LO, 6530LI  
6530LO-10-EU, 6530LO-10-FR,  
6530LO-10-FRA, 6530LO-10-DE  
28-30/37mBar & 50mBar



MODEL No 6530LI



MODEL No 6530LO,  
6530LO-10-EU, 6530LO-10-FR,  
6530LO-10-FRA, 6530LO-10-DE



# USER INSTRUCTIONS

GB DE DK ES FR IT NL NO PL SE SI

**CAUTION**  
For Outdoor use only!

This appliance may not be used in an exterior enclosed balcony, porch or entertainment area!

**IMPORTANT**

Read these instructions for use carefully so as to familiarize yourself with the appliance before connecting it to its gas container. Keep these instructions for future reference.

## 1. General information

- This appliance has been designed to be used for outdoor cooking, specifically for people who go camping to enjoy outdoor life and it can also be used at home on your patio.
- Various food types can be prepared on this appliance. The Camp Chef is designed to utilise various cooking surfaces.
- Gas is supplied to the unit via a hose and regulator (Low Pressure model) or connects directly to a disposable cartridge (High Pressure model). The hose and regulator can be connected to gas cylinder, a gas cartridge, or a CADAC Power Pak 1000 which is a unit that takes two gas cartridges. (Not supplied with the appliance).
- The unit is easy to switch on, and to operate (Section 6) and the user can control the heat input with an adjustable valve.
- The unit is supplied with a convenient carry bag.
- This appliance complies with EN498:2012 and SANS 1539:2012
- When using a pot, the minimum recommended pot size is 150mm and maximum recommended pot size is 230mm.
- This appliance may only be used with an approved hose and regulator connected to a refillable cylinder complying with the local regulation in force.
- The refillable cylinder is to be used only in an upright position. Only to be used with a gas cylinder that does not exceed 500mm in height and 350mm in width (including the regulator).
- Warning:** Accessible parts may be very hot. Keep young children away.
- Gas appliances require ventilation for efficient performance and to ensure the safety of users and other persons in close proximity, therefore do not use the appliance in an unventilated area. It is intended for use outdoors only.
- Read these instructions carefully before using the appliance.
- Use outdoors only!**

6530L0, 6530L1				
<b>Country of Use</b>	BE, CH, CY, CZ, ES, FR, GB, GR, IE, IT, LT, LU, LV, PT, SK & SI	PL	BE, CY, DK, EE, FR, FI, HU, IT, LT, NL, NO, SE, SI, SK, RO, HR, TR, BG, IS, LU, MT, & ZA	AT, CH, DE & SK
<b>Appliance Categories</b>	I <sub>3</sub> +(28-30/37)	I <sub>3B/P</sub> (37)	I <sub>3B/P</sub> (30)	I <sub>3B/P</sub> (50)
<b>Allowable gasses</b>	Butane	Propane	Butane, Propane or their mixture	
<b>Gas Pressure</b>	28-30mBar	37mBar	37mBar	28-30mBar (2.8kPa for South Africa) 50mBar
<b>Jet Number</b>	0.65	0.59	0.65	0.56
<b>Nominal Usage</b>	130g/hr	130 g/hr	130g/hr	130 g/hr
<b>Gross nom. heat input</b>	1.8kW	1.8 kW	1.8kW	1.8 kW

Country Name and Abbreviations				
AE = United Arab Emirates	AL = Albania	AT = Austria	BE = Belgium	CH = Switzerland
CZ = Czech Republic	DE = Germany	DK = Denmark	ES = Spain	FI = Finland
FR = France	GB = United Kingdom	GR = Greece	HR = Croatia	IT = Italy
JP = Japan	KR = Korea	NL = Netherlands	NO = Norway	PL = Poland
PT = Portugal	RO = Romania	RU = Russia	RS = Serbia	SI = Slovenia
SK = Slovakia	SE = Sweden	TR = Turkey	ZA = South Africa	

## 2. Safety Information

- Do not move the appliance during use.
- Turn off the gas supply at the gas cylinder after use.
- The hose must be checked for wear or damage before every use and before connecting to the gas container.
- Do not use the appliance if it has a damaged or worn hose. Replace it.
- Do not use an appliance that is leaking, damaged or which does not operate properly.
- This appliance must be kept away from flammable materials during use. Minimum safe distances are: Above the appliance 1.2m. At the rear and sides 600mm. (See Fig. 3)
- Ensure that the gas container is fitted or changed outdoors, away from any sources of ignition, such as naked flames, pilots, electric fires and away from other people.
- Keep gas containers away from heat and flame. Do not place on a stove or any other hot surface.
- Ensure that the assembled product is stable and does not rock.
- In the event of light back (where the flame burns back and ignites at the jet), immediately turn off the gas supply by closing the control valve on the gas container and then the appliance valve. After the flame is extinguished remove the regulator and check the condition of its seal. Replace the seal, if in doubt. Re-light the appliance as described in section 6 below. Should the flame persistently light back, return the product to your authorised CADAC repair agent.

- If there is a leak on your appliance (smell of gas), close the cylinder valve immediately and take it into a flame free location where the leak may be detected and stopped. If you wish to check for leaks on your appliance, do it outside. Do not try to detect leaks using a flame; use soapy water.
- The correct way is to smear the joints e.g. where the stem fits into the cylinder, with soapy water.
- If bubbles form, then there is a gas leak. Immediately turn off the gas supply by closing the control valve on the gas container and then the appliance valve. Check that all the connections are properly fitted. Re-check with soapy water.
- If a gas leak persists, return the product to your CADAC dealer for inspection / repair.
- **Use Outdoors Only.**

### 3. Assembly Instructions

- **WARNING:** The legs are spring loaded. Opening and closing of the legs must be done in a controlled manner to avoid personal injury or damage to your Camp Chef.
- To open the legs, turn the unit upside-down and hold the legs down while lifting each leg individually. You will hear a "click" if the leg(s) has located correctly.
- To fold the legs back, securely hold the leg and push the Leg Release Clip down. Then push the legs in-ward to its closed position (Fig 6). This needs to be done sequentially to optimise space. First the Right front leg (1), Then the Left front leg (2), and lastly the rear Leg (3) (Fig 4b).
- Before connecting the gas supply, firstly check that the appliance valve is in the off position by turning the control knob fully clockwise (See Fig. 2).
- **I 3B/P (30), I 3+ (28-30/37) and I 3B/P (37) Appliance categories:** Fit the Valve Tailpiece onto the Valve (Fig.5) by screwing it on in an anti-clockwise direction. Push an 8mm inside diameter Hose onto the Valve Tailpiece until it is properly seated. On the other end attach a suitable 30mbar low-pressure (I 3B/P (30) and I 3+ (28-30/37) Butane configurations) or 37mBar low-pressure regulator (I 3+ (28-30/37) Propane configuration), again making sure that the hose is well seated. The hose used must comply with BS 3212 / SABS 1156-2 or equivalent.
- **I 3B/P (50) Appliance category:** Screw a Hose with the correct threaded fittings on each end, onto the left hand 1/4" BSP thread of the Valve. Attach a suitable 50mbar low-pressure regulator on the other end of the hose. The hose used must comply with DIN 4815 part 2 or equivalent.
- **Note:** The hose and regulator are not supplied with the appliance. For details, contact your local stockist.
- The hose length should be no less than 800 mm and shall not exceed 1.5 m. Check the expiry date on the hose and replace when necessary or when national conditions require it. Do not twist or pinch hose.
- Your appliance is now ready for use.

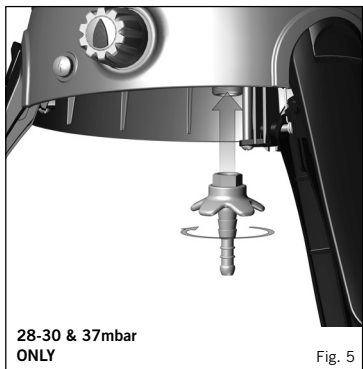
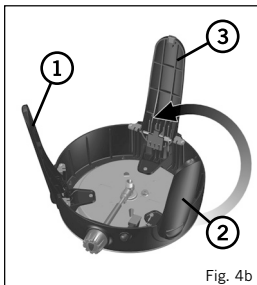
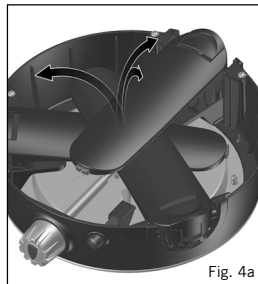
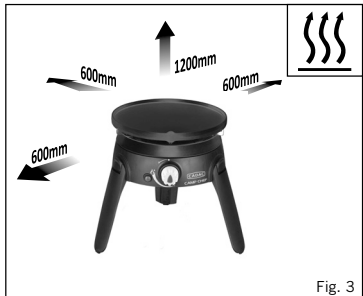
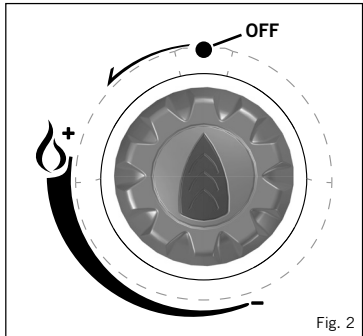
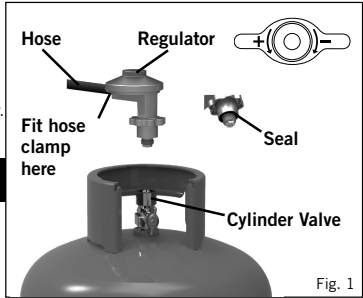

## 4. Component List

### Camp Chef - Low Pressure

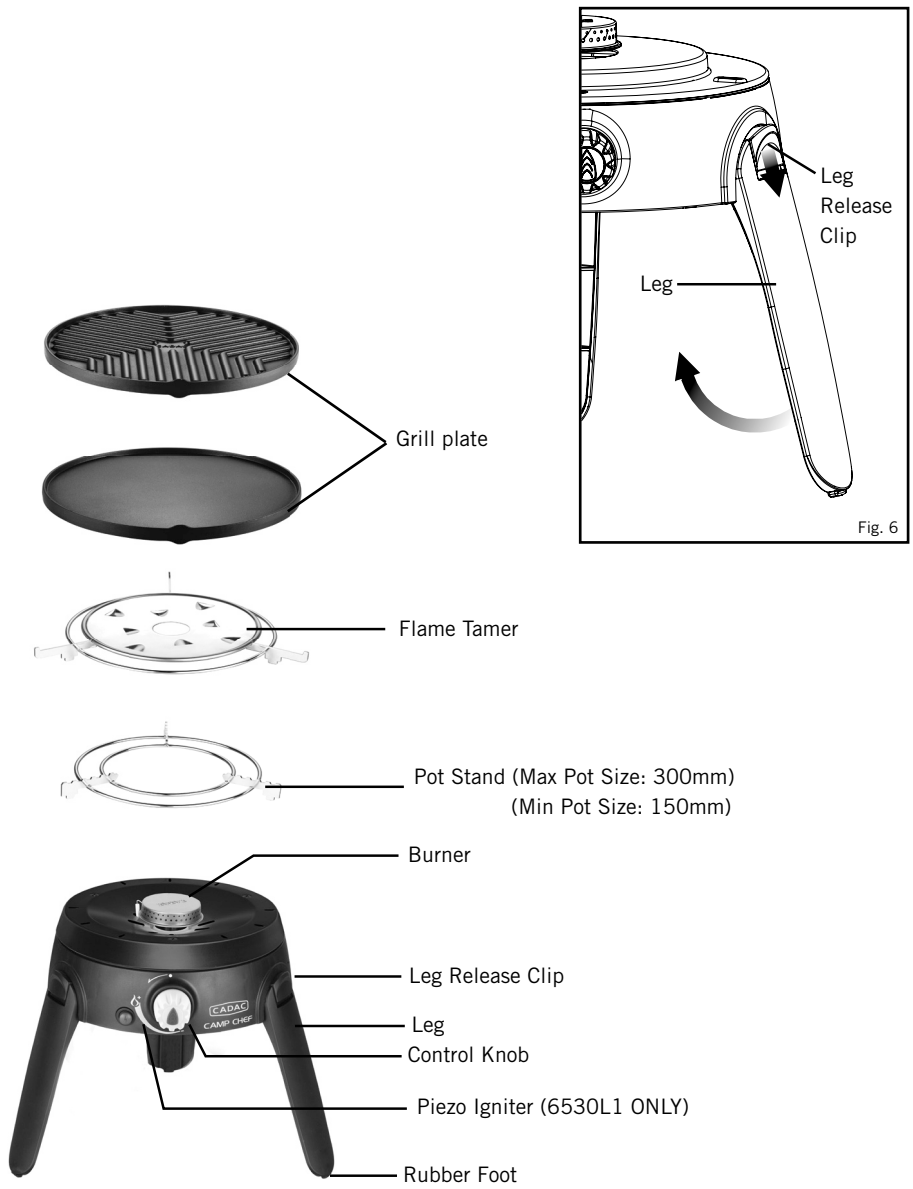

Fig. 7

## 5. Fitting and Changing the Hose and Gas Cylinder

- Before fitting the regulator to a gas container, ensure that the seal on the regulator is in position and in good condition. This should be done on every connection.
- Ensure that the gas container is fitted or changed outdoors, away from any source of ignition, such as naked flames or electric fires and away from other people.
- Making sure that the gas container is kept upright, screw the regulator onto the gas container until it is fully engaged. Do not over tighten.
- If there is a leak on your appliance (smell of gas), take immediately into a flame-free location where the leak may be detected and stopped.  
If you wish to check for leaks on your appliance, do it outside using soapy water only, which is applied to the joints. A formation of bubbles will indicate a gas leak.
- Check that all the connections are securely fitted and re-check with soapy water. If you cannot rectify the gas leak, do not use the appliance. Contact your local CADAC stockist for assistance.
- When changing a gas container close the cylinder valve and then the appliance Valve (see Figs. 1 and 2). Making sure the flame is extinguished, unscrew the regulator. Re-fit a full gas container following the same precautions as described above.

## 6. Using the Appliance

- This appliance must be used outdoors only!
- When in use, protect from wind for optimum performance.
- Do not move the unit whilst hot. The use of protective gloves is recommended.
- **CAUTION:** Accessible parts may become very hot. Keep young children away from the appliance.
- To pack away, let the unit cool. After cleaning, Fold the appliance as described in section 3 above.  
Fold over the lid of the bag, and zip it closed. (Fig 8)
- Keep the appliance in its Carry Bag when not in use, as this will prevent the ingress of dirt or insects which may affect the gas flow.
- When attempting to light the appliance, make sure that the gas supply from the cylinder is open prior to turning on the gas supply to the appliance.
- Using the control knob  
The control knob is fitted with two positive stop positions, one at low, and one at Ignite / High. This limits the adjustment of the flame to between these two points.
- Lighting up using the Piezo Igniter  
To light up the appliance using the piezo igniter, push in and turn the control knob in an anti-clockwise direction until you hear a click. If the gas does not ignite on the first spark, push in, and turn the control knob fully clockwise. Try again, by pushing in and turning the control knob anti-clockwise until you hear a click. If the gas has not ignited in the first two to three seconds you should close the control valve by pushing in the control knob, and turning it fully clockwise. Wait approximately thirty seconds to let any accumulated gas within the burner pan assembly escape. Repeat the above process if necessary until the flame ignites. The flame should normally light up within the first one or two seconds.
- Lighting up using a BBQ lighter  
When starting cold, the appliance may be lit from the top prior to fitting the desired cooking surface onto the fat pan. When lighting up a hot appliance however, it is recommended that this be done by sticking barbecue lighter through one of the Vent Holes underneath the Burner, until it is in line with the burner (DO NOT place the BBQ lighter through the large hole directly underneath the burner). Ignite the BBQ lighter. Whilst the BBQ lighter is lit, push in and turn the control knob anti-clockwise to light the burner.
- Use the control knob to adjust the flame intensity to the desired level by turning the knob clockwise to decrease the flame and anti-clockwise to increase the flame.
- When not in use disconnect the appliance from the gas supply.
- **WARNING:** Do not use any cooking surfaces on a high flame setting for more than 10 minutes as this can damage the non-stick coatings.



Fig. 8

## 7. Cooking Options

- There are three available cooking options with your Camp Chef appliance. These are:  
**Grilling:** This cooking option is ideal for grilling of chicken, sausages, chops, kebabs, fish or vegetables. For this type of cooking, place the grill plate onto the pot stand.

**Caution:** Please use caution when handling such meats. The cooking temperatures are easily adjusted to suit your own requirements by turning the Valve Knob to regulate the degree of heat.

**Frying:** This option is ideal for stir-fries, fish, breakfast, pancakes, prawns, paella and vegetables. For this type of cooking. Place the Flat Pan onto the potstand. Please note that being a shallow pan, it is not suitable for deep-frying. The easy clean surface encourages the minimum use of fat for healthy cooking.

**Boiling:** For this type of cooking, place the Pot stand in its locator grooves on the heat shield ensuring that it is properly seated. Place a suitable pot (not less than 150mm diameter and not more than 230mm diameter) on the Pot Stand. One liter of water will boil in approximately 6 minutes depending on the conditions, size of pot used, etc. Note: When using small sized pots do not attempt to use pots with plastic handles.

### Barbecuing



### Frying



### Boiling



## 8. Cleaning

### BBQ Unit

- To clean the Flat Pan, and BBQ Grid, wash in warm water with a non-abrasive detergent after first wiping off any excess fat left after cooking.
- Do not use an abrasive cleaner on any part, as this will damage its surface coating.
- These parts are perfectly safe to clean in the dishwasher after removing any excess fat.

### Body / Leg Unit

- This is best cleaned by using a soft damp cloth and a mild non-abrasive detergent. Do not place in a dishwasher as this may allow water into the valve or burner ports, which will cause the unit to malfunction.
- When cleaning the body/leg unit the pot stand may need to be removed. This can be done lifting the pot stand out of the locator groove in the heat shield.

## 9. General Maintenance

- The onus of maintaining this appliance solely rests on the consumer from date of purchase.
- This appliance does not require scheduled maintenance.
- After prolonged storage, inspect the Air Holes under the unit and the inlet of the venturi for insects such as spiders, etc which could affect gas flow. Also inspect the inlet of the Venturi for insects. After checking, refit all components into the prescribed position.  
Replacing a Blocked Jet:
- Your Camp Chef is fitted with a specific size jet to regulate the correct amount of gas.
- Should the hole in the Jet become blocked, this may result in a small flame or no flame at all. Do not attempt to clean the Jet with a pin or other such device as this may damage the orifice, which could make the appliance unsafe.
- **To replace the Jet:** Gently unscrew the burner assembly (Fig. 10). Remove the three screws from the heat shield plate and remove the Heat Shield (Fig. 11), **taking care not to damage the piezo electrode.** The Jet can now be removed using a suitable spanner (Fig. 12). Do not use pliers on the jet as this may damage the jet, making it unusable or impossible to remove. Screw the new jet into the valve. Do not over-tighten as this may damage the jet.
- Reverse the above procedure to re-assemble the unit.  
Replacing the Hose:
- The fitting of a hose is described in Section 5 - Fitting and replacing the hose and gas cylinder.

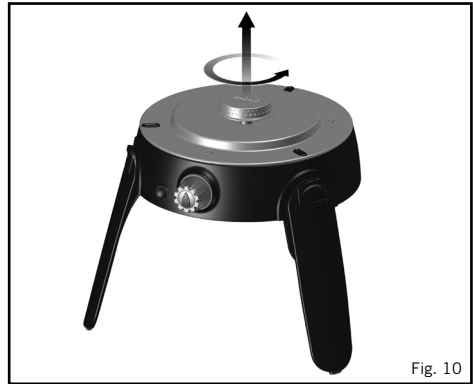

Fig. 10



Fig. 11

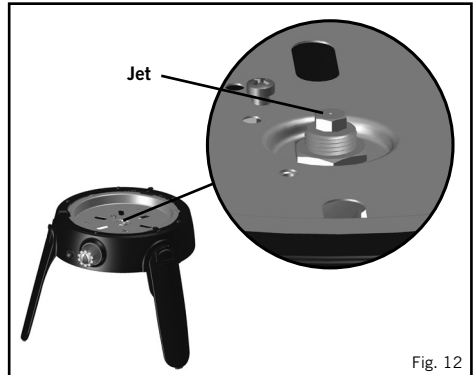

Fig. 12

## 10. Returning the appliance for repair or service.

- Do not modify the appliance, as this could be dangerous.
- If you cannot rectify a fault by following these instructions, contact your local CADAC distributor for details on how to return the product for attention.
- Your CADAC Camp Chef is guaranteed by CADAC for a period of 2 years against factory fault.

## 11. Spares and Accessories

- Always use genuine CADAC spares as they have been designed to give optimum performance.

Description	Part No.	Description	Part No.
Jet: 0.65mm (28/30mBar)	6530-SP001	Control Knob	6530-SP015
Jet: 0.56mm (50mBar)	6530-SP002	Piezo Assembly	6540-SP008
BBQ Grid	6530-SP007	Leg (Left / Right)	6540-SP010
Pot Stand	6530-SP003	Leg (Rear)	6540-SP009
Burner Assembly (28/37mbr)	6530-SP008	Carry Bag	6530-SP004
LP Valve (28/37mbr)	6540-SP016	Silicone Spacer	6530-SP019
LP Burner (50mbr)	6530-SP021	LP Valve (50mbr)	6530-SP018
Jet: 0.59mm (37mBar)	6530-SP031		